

Be-Gradient Barrier-Free

Product guide

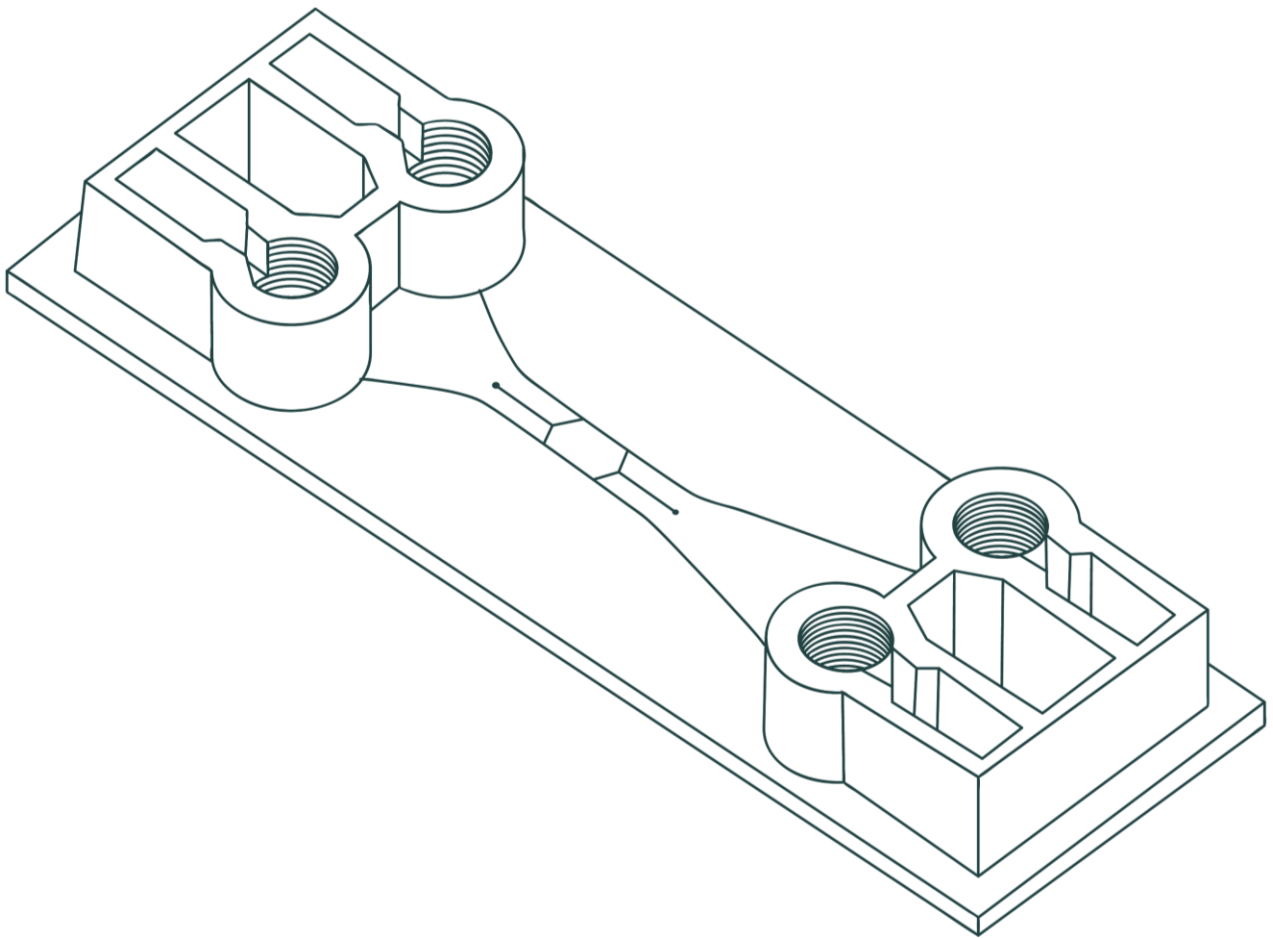

Table of contents

About Be-Gradient Barrier-Free	3
Technical features.....	4
Content.....	5
Filling and handling	6
Cell Culture.....	7
Flow set up	10
Culture models	11
Contact and support	12

About Be-Gradient Barrier-Free

BE-Gradient Barrier-Free is our device designed for electrochemical gradient application to 3D cell cultures and for creating barrier models. It is compatible with any type of optical microscopy (inverted phase contrast, confocal, fluorescence, etc). Be-Gradient consists of a cell culture chamber and two channels in direct contact with it. Changing the concentration of one element between the channels on both sides of the central chamber results in the creation of a chemical gradient of that element in the central chamber. For barrier and vasculature models, the lateral channels are meant to simulate blood vessels, where endothelial cells can be cultured.

Technical features

Be-Gradient Barrier-Free has a horizontal structure for **optimal imaging**, having all structures at the same height. The chamber can confine a hydrogel and so is designed for **3D cell culture**. The two channels flanking the chamber function as **media perfusion** and are directly communicated with the chamber, allowing nutrient and oxygen supply to the central chamber.

For further instructions regarding proper use of the device check the following sections.

	Height	Width	Length	Total volume
Central chamber	200 μm	3 mm	4,5 mm	6,2 μL
Channel	200 μm	1 mm	50 mm	10 μL
Inlet/Outlet	7 mm	UNF 1/4" - 28		130 μL
Medium reservoir	5 mm	3,6 mm	8,8 mm	185 μL

* The volumes presented in the table are theoretical values calculated for the standard products. Changes in the device features of custom chips may modify the exact channel volume.

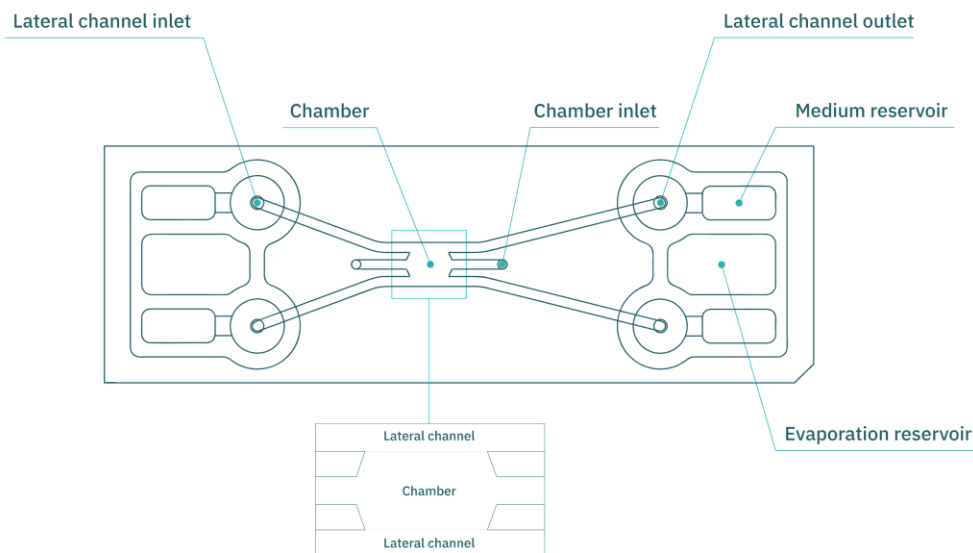

Content

The box contains **10 BE-Gradient Barrier-Free** chips that are **individually packaged**. Each chip undergoes a sterilization process before sending the chip to the final user. It can be stored in **dry places** that are **not exposed to direct sunlight** at room temperature (**15-25°C**).

Filling and handling

Before seeding, prewarm the device in the incubator overnight to avoid the appearance of air bubbles.

The **chamber must be completely clean and dry** in order to confine the hydrogel in it.

When filling the channels up, **place the tip of the pipette completely vertical** into the channel's inlet pinhole. Inject the liquid with a **continuous and constant flow** to avoid backward flow.

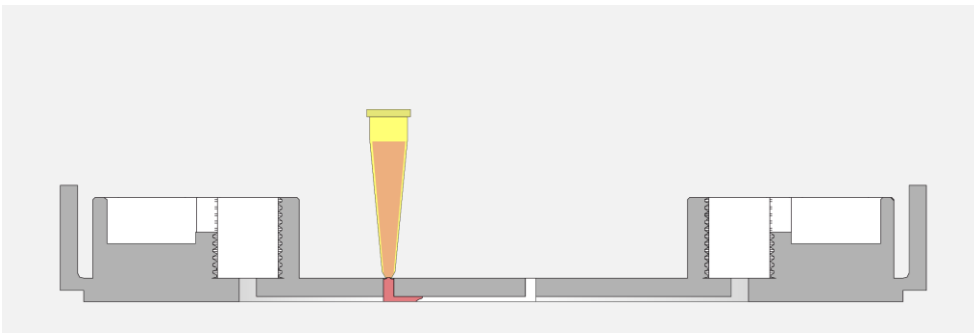

Use the **lateral holders** for easy and safe handling.

Cell Culture

1. **Trypsinize** and **count cells** as usual.

2. **Inject the mixture of cells** and hydrogel in the culture chamber by **pipetting through the central inlet** by one of the two following ways:

- a. **Inject the solution (10 μL) slowly** into the chip. First, the meniscus will enter into the chamber (A). Continue until the chamber is half filled (B-C). Then, inject the remaining solution slowly into the chip through the central outlet until the chamber is fully filled (E-G). When changing the tip from the inlet to the outlet to finish injecting the solution, keep pressing the pipette plunger so air does not enter the pipette tip.

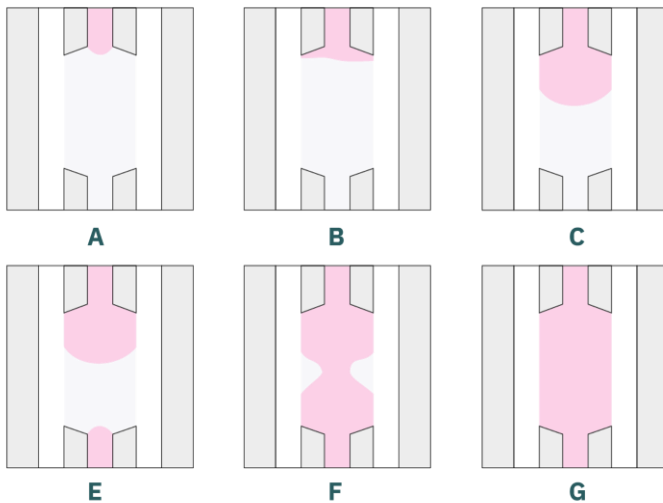

- b. **Inject the solution (10 μL) slowly** into the chip. First, the meniscus will enter into the chamber (A). Continue until the chamber is fully filled (B-F).

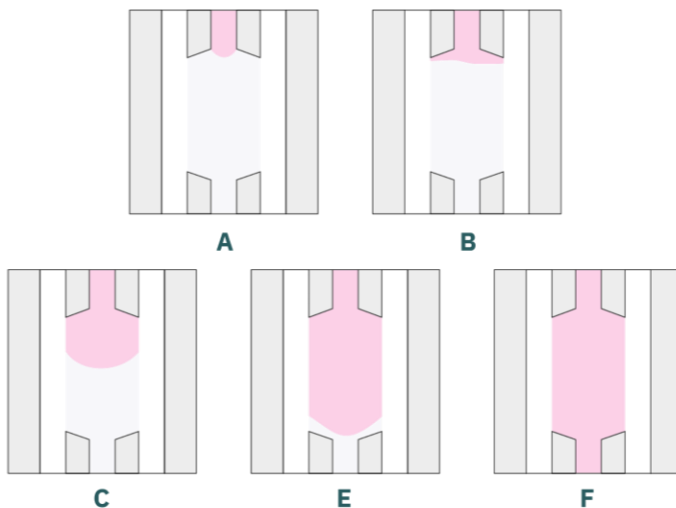

3. **Flip the chip upwards and downwards** every 30 seconds for a few minutes for **homogeneous 3D distribution** during the polymerization of the hydrogel.

Disclaimer: the time between flips and incubation might vary according to the type of hydrogel. Check the hydrogel manufacturer's conditions.



4. Seal the central chamber inlet and outlet with the adhesive provided. Make sure that the surface is clean to ensure proper adhesion.

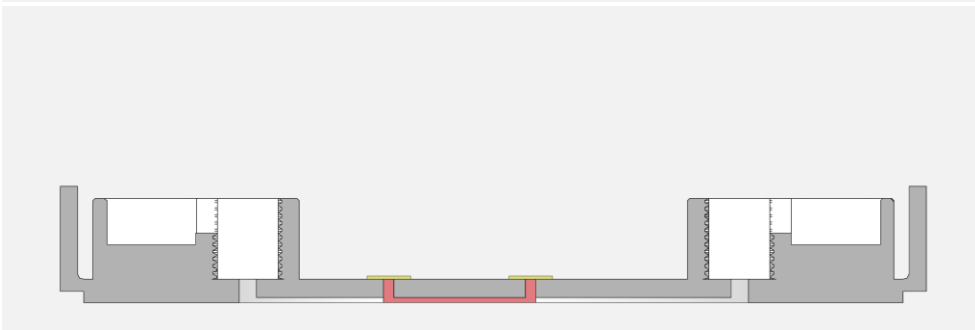
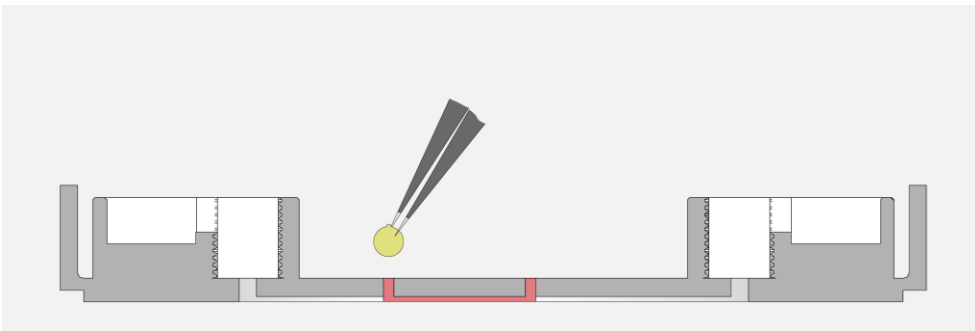

5. Add medium to the reservoirs to fill the lateral channels. Gently aspirate the culture medium through the opposite inlet.

- a. Add PBS/water to the evaporation reservoir.
- b. Additionally, place an opened Eppendorf's with sterilized water inside the petri dish to increase humidity and avoid fast evaporation.



6. Cover and incubate until needed.

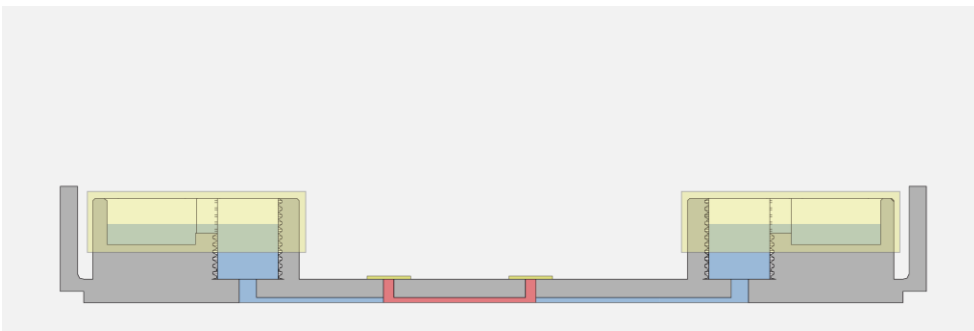

7. Refresh the medium according to cellular requirements. You may refresh the medium manually at different time points or constantly with a rocker.

Remember that our devices allow the thorough **control of the culture conditions and the recreation of hypoxia conditions** because COP has very low gas permeability. **A correct and frequent replenishing of the media through the lateral channels is important to bring oxygen and nutrients to the culture.**

Important: Do not remove the medium inside the channel during medium refreshing. This will prevent the entrance of air bubbles. Thus, when removing the solution, place the tip of the pipette away from the pinhole to avoid emptying the channel.

Note that the channels should never dry up after the medium is added. Take incubation times into account and use the evaporation reservoirs as long as possible.

Flow set up

Before setting the flow up:

- **Sterilize and prewarm** the tubes and the fluidic elements overnight at 37°C.
- Set the system in a **laminar flow cabinet**.
- **Hydrogel must be fully polymerized** before mounting the perfusion system.
- The channels and inlet/outlet wells should **never be depleted of culture medium**.
- Inlets and outlets are designed to be for **screw connectors (1/4" - 28)**.

For more information regarding connecting a microfluidic flow system check our website. [Link](#).

Connecting a perfusion system

- 8. Remove the medium** from the reservoirs.
- 9. Screw the outlet connector** and ensure that the tube is perfectly fixed.
Remove the displaced medium from the reservoir.
- 10. Prime the tube** that will **connect to the inlet** before assembling. This will **prevent air bubbles** from entering the device.
- 11. Screw the inlet connector** and remove the displaced medium from the reservoirs.
- 12.** Once the system is closed, **switch the flow on**.

Check that there are **no leaks** in the system by leaving the pump **running for a couple of minutes** before placing the device in the incubator. Medium reservoirs will be filled up if the connections are not completely closed.

See YouTube video: [Be-Gradient Barrier-Free: Cell Culture](#).

Culture models

Find several of the most frequently used culture models on the Be-Gradient Barrier-Free below.

- (1). Cell/spheroid invasion and migration** by chemotaxis stimuli.
- (2). Ischaemia model.** Depending on cell type metabolism, cell density, flow conditions, nutrients & oxygen availability, tumour and ischemia models can be performed.
- (3). Angiogenesis and endothelization.**
- (4). Blood-brain barrier models** with neurons and glial cells seeded in the central chamber and endothelial cells in the lateral channels.

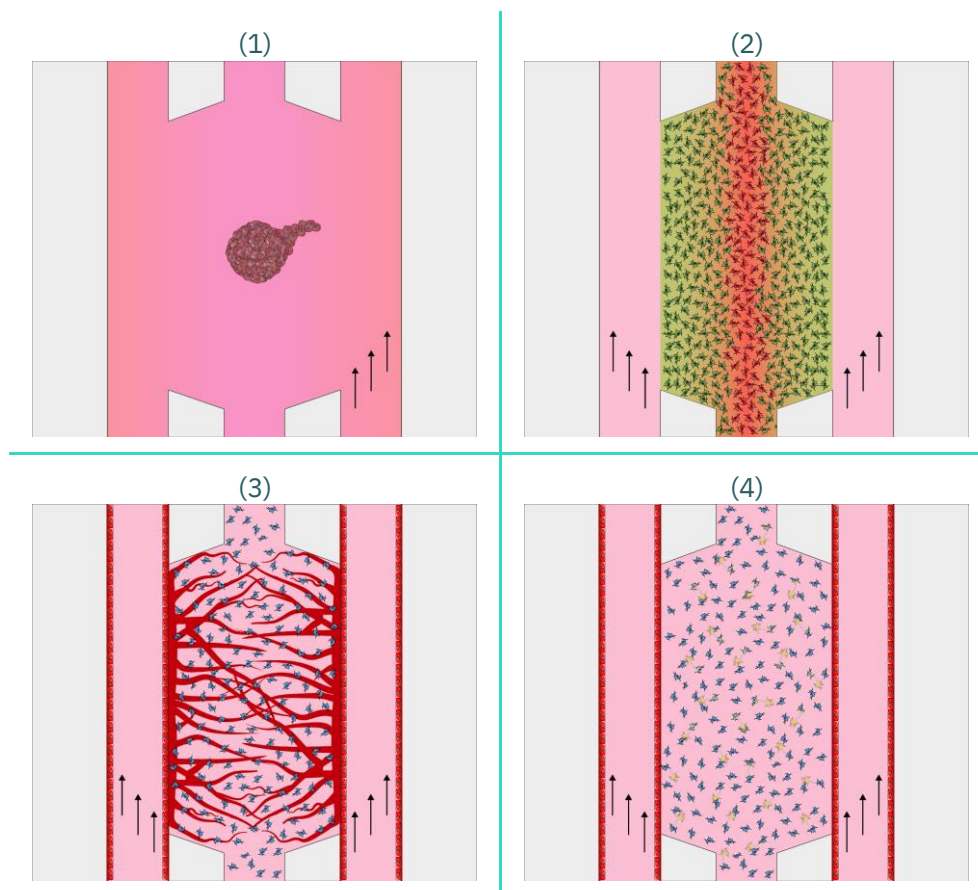

Contact and support

Our team of technicians will be happy to help you with any questions about the operation of our devices. **You can contact us on the following channels:**

info@beonchip.com

+34 655 16 16 91

www.beonchip.com

Beonchip S.L.
Campus Río Ebro
Mariano Esquillor s/n
Edificio CEMINEM
50018, Zaragoza, Spain

